



# HEAT PUMPS FOR HEATING AIR-TO-WATER

Product Catalogue



**NEW  
OUTDOOR  
UNIT**

**Decades of heating.  
Decades of comfort.**

# Outstanding efficiency

**KEY ADVANTAGES OF THE PAST MODELS OF HEATING SYSTEMS' OUTDOOR UNITS ALSO IN THE NEW MODELS**

- High heating performance
- High heating power at very low outdoor temperatures

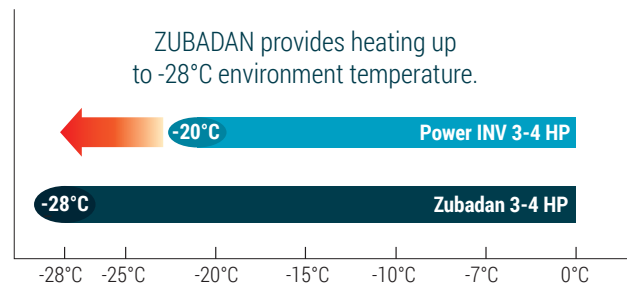
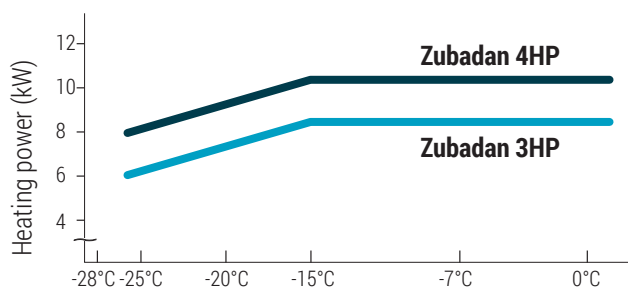

## The Zubadan series achieves a high heating power at very low outdoor temperatures

The heating system in combination with the outdoor unit ZUBADAN is suitable for the coldest areas since it provides high heating power even at very low outdoor temperatures:

- **The unique technology »Flash Injection« enables preservation of the nominal heating power even at outside temperatures up to -15 ° C.**
- **Ensured heating at -28 ° C outside temperatures.**

Excellent heating features of ZUBADAN units reflect the technology of the Flash Injection effective gas circulation, the result of the research by MITSUBISHI ELECTRIC experts.

While conventional heating pumps lose their heating power because of the drop in the range of gas circulation through the system, the unique bypass circuit "Flash Injection" improves the circulation volume of gas using two circulatory systems.

This technology provides high efficiency and reliable heating of facilities in the coldest areas.

### ZUBADAN Flash Injection Circuit

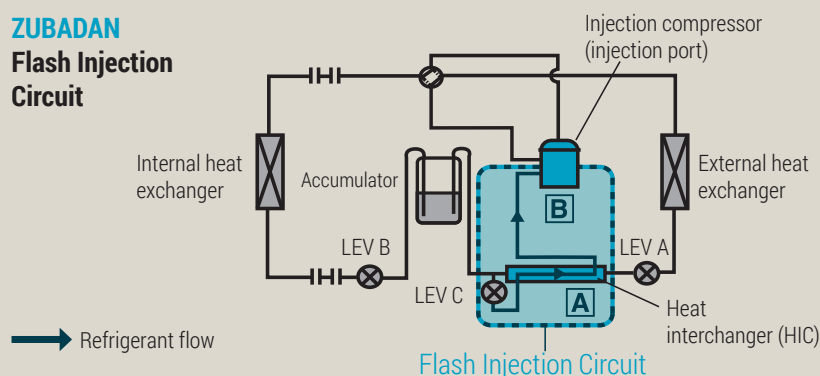



# ng



## HIGHEST ENERGY CLASSES

The heart of the system, which belongs to the highest A++ energy efficiency class of heating, is a highly efficient compressor

for units PUAZ-SW100V / YAA, PUAZ-SHW80V / YAA, PUAZ-SHW112V / YAA.



### A Heat interchanger (HIC)

Cross-section

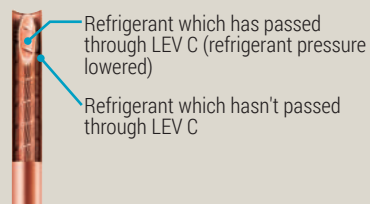

### Operation at extremely low outdoor temperatures is the prime feature of the Zubadan outdoor unit series

In the process of heat exchange at point A (heat exchanger), the fluent refrigerant is converted into a two-phase gas-liquid state and is then compressed at point B (injection compressors). This circuit provides sufficient speed

### B Injection Compressor

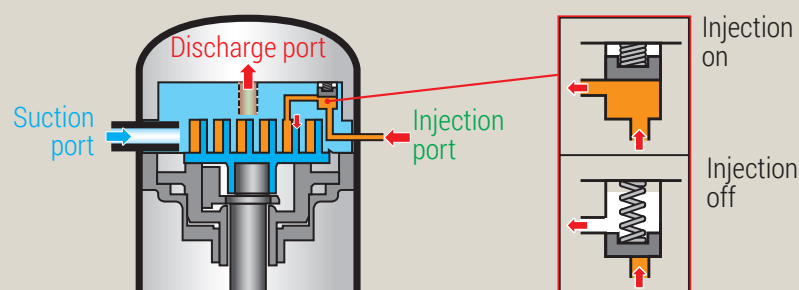

of the refrigerant's flow for heating even at extremely low outdoor temperatures.

For the new generation of Zubadan units, the Flash Injection circuit is stronger because the **heat exchanger is improved** and therefore the efficiency of the **heat exchange is enhanced**. Furthermore, a new injection

compressor is built in hence the effect of compression increases even more. These two features provide efficient heating at extremely low outdoor temperatures.



## IMPROVEMENTS OF THE NEW OUTDOOR UNITS

# 1 Silent operation

New fan and the periphery of the compressor enable a 10 dB(A) quieter operation

Reducing the sound power level is a key advantage of the new model compared to previous models. Quiet operation is not at the expense of loss of heating power since Mitsubishi Electric's outdoor units are the strongest among their competitors.

### By far the quietest outdoor unit of its kind

The result is barely audible. In conjunction with an intelligent speed control unit, the high grade, sound-optimized fans significantly contribute to reducing airborne noise in full and partial load operation. Low frequencies

that are generally perceived as nuisance in conventional heat pumps are prevented.

### 35 dB (A) at a distance of only 4 metres

In night mode, the sound power levels of fan and compressor are further reduced. This feature is important in places where statutory requirements must be met on acoustic emissions (TA Lärm: 35 dB(A)), particularly in areas that are densely developed, such as in terraced houses.

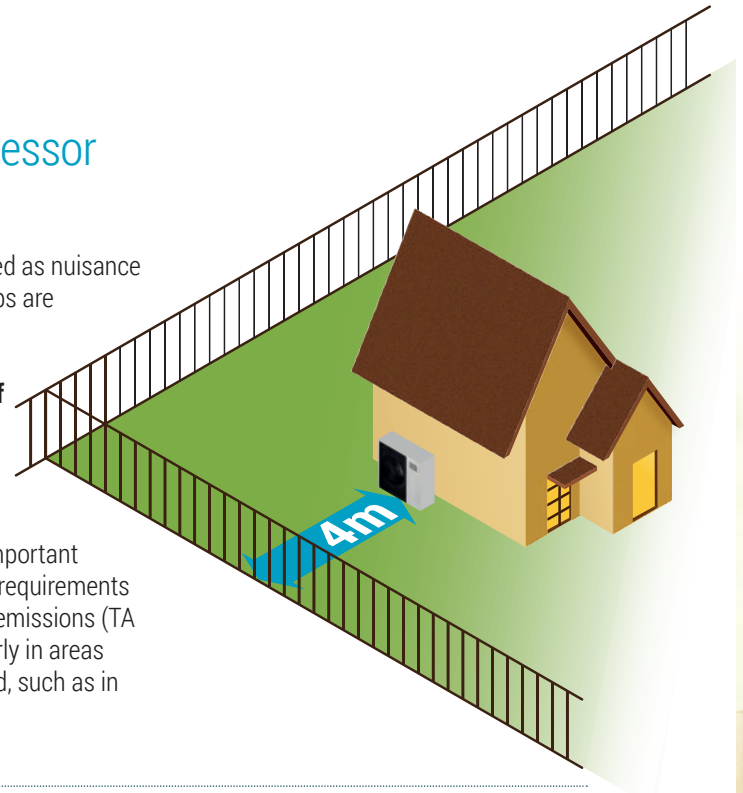

## THREE KEY IMPROVEMENTS OF THE OUTDOOR UNIT ENABLED THE REDUCTION OF THE OPERATION VOLUME:

### REDUCED VOLUME OF COMPRESSOR OPERATION

The technology of the protective covering reduces the sound coming from the compressor

Improvements of volume reduction:

- patented structure of the compressor's covering
- housing with protective covering

### REDUCED VOLUME OF FAN OPERATION

Optimized airflow outlet through the fan

Improvements of fan volume reduction:

- optimized position of the fan
- optimized shape of the fan's mouth
- a larger fan diameter

### PREVENTION OF VIBRATIONS

Absorption of vibrations and prevention of resonance

Improvements of vibration and resonance prevention:

- a soft piece of rubber in the area of the compressor's pipe connection that absorbs vibration,
- optimized structure of the pipes, which prevents resonance.

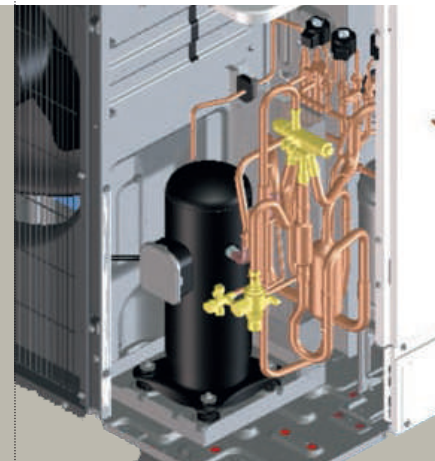
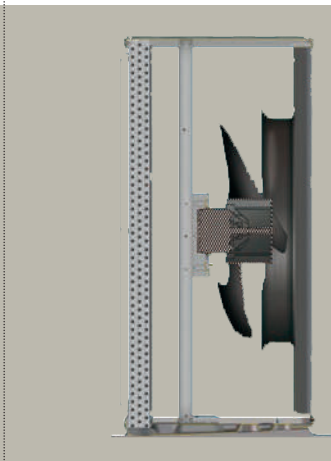



## 2 Compact design

Less space needed for the single unit itself, as well as in front of it.

The economy of space is certainly one of the advantages of the new Mitsubishi outdoor units Zubadan. The units occupy significantly less space than competitive units.

Much smaller space is required for the operation in front of the device itself, and takes up only 350 mm with the new Mitsubishi Electric outdoor units.

### Dimensions

Height (mm)	Depth (mm)	Width (mm)	Volume (m <sup>3</sup> )
1020	480	1050	0.51



## 3 High reliability

Optimized defrosting and prevention of ice accumulation

A new design of the base is more reliable than ever before:

- improved drainage
- optimized defrost control
- optimized heat exchanger that prevents the formation of ice on the outdoor unit.

### New base design

- optimized structure of the base improves drainage flow
- inclination of the base enables smooth and faster drainage



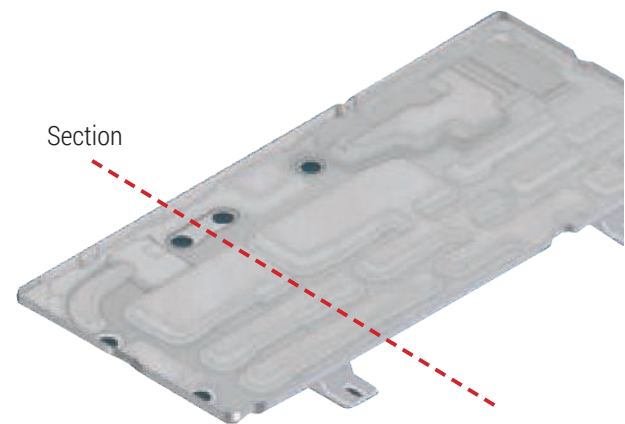

Section

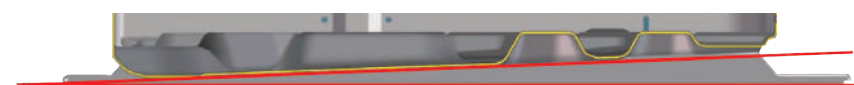

Section



# OUTDOOR UNITS MITSUBISHI ELECTRIC

SPLIT TYPE	VOLTAGE	MODEL	
	230V	PUHZ-SHW80VAA (8 kW), PUHZ-SHW112VAA (11,2 kW)	 NEW!
	400V	PUHZ-SHW80YAA (8 kW), PUHZ-SHW112YAA (11,2 kW)	
	230V	PUHZ-SW75VAA (7,5 kW), PUHZ-SW100VAA (10 kW)	 NEW!
	400V	PUHZ-SW75YAA (7,5 kW), PUHZ-SW100YAA (10 kW)	

## TECHNICAL SPECIFICATIONS

MODEL OUTDOOR UNIT		PUHZ-SW75VAA	PUHZ-SW100VAA	PUHZ-SHW80VAA	PUHZ-SHW112VAA	PUHZ-SW75YAA	PUHZ-SW100YAA	PUHZ-SHW80YAA	PUHZ-SHW112YAA	
<b>Power supply</b>	(Phase, V, Hz)	1φ, 230V, 50Hz				3φ, 400V, 50Hz				
Operating Current (max.)	A	22.0	28.0	22.0	28.0	11.5	13.0	13.0	13.0	
Fuse	A	25.0	32.0	25.0	32.0	16.0	16.0	16.0	16.0	
Dimensions H×W×D	mm	1020×1050×480				1020×1050×480		1020×1050×480		
Weight	Net (kg)	92	114	116	116	104	126	128	128	
	Gross (kg)	107	129	131	131	119	131	143	143	
Heating	Medium temperature (W55), Medium climate	Design load (kW)	7.1	10.0	9.0	12.7	7.1	10.0	9.0	12.7
		SCOP	3.31	3.33	3.40	3.46	3.28	3.30	3.36	3.44
		η <sub>ns</sub>	129	130	133	135	128	129	132	135
		<b>Energy Efficiency Class</b>	<b>A<sup>++</sup></b>	<b>A<sup>++</sup></b>	<b>A<sup>++</sup></b>	<b>A<sup>++</sup></b>	<b>A<sup>++</sup></b>	<b>A<sup>++</sup></b>	<b>A<sup>++</sup></b>	<b>A<sup>++</sup></b>
		A7/W35	Power (kW)	8.0	11.2	8.0	11.2	8.0	11.2	8.0
A2/W35	<b>COP</b>	<b>4.40</b>	<b>4.46</b>	<b>4.65</b>	<b>4.46</b>	<b>4.40</b>	<b>4.46</b>	<b>4.65</b>	<b>4.46</b>	
	<b>Power (kW)</b>	<b>7.5</b>	<b>10.0</b>	<b>8.0</b>	<b>11.2</b>	<b>7.5</b>	<b>10.0</b>	<b>8.0</b>	<b>11.2</b>	
Domestic hot water (DHW)	η <sub>wh</sub>	COP	3.40	3.32	3.55	3.22	3.40	3.32	3.55	3.22
		Energy Efficiency Class	<b>A</b>	<b>A</b>	<b>A</b>	<b>A</b>	<b>A</b>	<b>A</b>	<b>A</b>	<b>A</b>
Cooling	A35/W7	<b>Power (kW)</b>	<b>7.1</b>	<b>10.0</b>	<b>7.1</b>	<b>10.0</b>	<b>7.1</b>	<b>10.0</b>	<b>7.1</b>	<b>10.0</b>
		<b>EER</b>	<b>2.70</b>	<b>2.83</b>	<b>3.31</b>	<b>2.83</b>	<b>2.70</b>	<b>2.83</b>	<b>3.31</b>	<b>2.83</b>
	A35/W18	Power (kW)	7.1	10.0	7.1	10.0	7.1	10.0	7.1	10.0
		EER	4.43	4.47	4.52	4.74	4.43	4.47	4.52	4.74
EER output water temperature	Heating (°C)	Heating (kg/min)	22.9	32.1	22.9	32.1	22.9	32.1	22.9	32.1
		Heating (kg/min)	22.9	32.1	22.9	32.1	22.9	32.1	22.9	32.1
The level of the water	Lot1 (kg/min)	Heating (kg/min)	14.3	20.1	14.3	20.1	14.3	20.1	14.3	20.1
		Cooling (kg/min)	20.4	28.7	20.4	28.7	20.4	28.7	20.4	28.7
<b>Sound power Level 35dB(A) on distance from*:</b>	<b>m</b>	<b>4</b>	<b>5</b>	<b>4</b>	<b>5</b>	<b>4,5</b>	<b>5</b>	<b>4,5</b>	<b>5</b>	
Sound power level	Heating	dB(A)	58	60	59	60	58	60	59	60
Piping	liquid / gas (Φmm)	9.52 / 15.88 (3/8", 5/8")				9.52 / 15.88 (3/8", 5/8")				
	Max. length (m)	40	75	75	75	40	75	75	75	
	Chargeless (m)	10	10	30	30	10	10	30	30	
	Max. Höhenunterschied (m)	30		30		30		30		
Refrigerant		R410A(GWP2088)		R410A(GWP2088)		R410A(GWP2088)		R410A(GWP2088)		
	Chargeless (kg)	3.0	4.2	4.6	4.6	3.0	4.2	4.6	4.6	
	CO <sub>2</sub> equivalent (t)	6.27	8.77	9.61	9.61	6.27	8.77	9.61	9.61	
	Max. (kg)	4.8	6.0	6.0	6.0	4.8	6.0	6.0	6.0	
	CO <sub>2</sub> equivalent (t)	10.03	12.53	12.53	12.53	10.03	12.53	12.53	12.53	
Guaranteed area of operation	Heating (°C)	-20 do +24	-20 do +24	-28 do +24	-28 do +24	-20 do +24	-20 do +24	-28 do +24	-28 do +24	
	Domestic Hot Water (°C)	-20 do +35	-20 do +35	-28 do +35	-28 do +35	-20 do +35	-20 do +35	-28 do +35	-28 do +35	
	Cooling (°C)	-15 do +46	-15 do +46	-15 do +46	-15 do +46	-15 do +46	-15 do +46	-15 do +46	-15 do +46	

\* Data about distance for Sound power Level 35dB(A) is calculated in Night mode.



# INDOOR UNITS ORCA



## TECHNICAL SPECIFICATIONS



### INDOOR UNIT

### MONO wall mounting indoor unit

Dimensions of gas connections (Φmm)	9.52 / 15.88 (3/8", 5/8")
Dimensions of connections for the heating system (Φmm)	25.4 (1")
Built-in circulation pump	circulation pump - energy class A
Electric heater (kW)	3×3
Heat exchanger	Swep
Expansion vessel for heating (L)	12
Switchover heating – hot water	Integrated
Power supply (Phase, V, Hz)	3φ, 400V, 50Hz
Dimensions H × W × D (mm)	900×600×400
Weight (kg)	80



### INDOOR UNIT

### DUO 200 with the 200 L tank for domestic hot water

Hot water tank volume (L)	200
Dimensions of gas connections (Φmm)	9.52 / 15.88 (3/8", 5/8")
Dimensions of connections for the heating system (Φmm)	25.4 (1")
Dimensions of hot water connections (Φmm)	25.4 / 19.05 circulation (1", 3/4 circulation)
Built-in circulation pump	circulation pump - energy class A
Switchover heating – hot water	Integrated
Electric heater (kW)	3×3
Heat exchanger	Swep
Expansion vessel for heating (L)	12
Power supply (Phase, V, Hz)	3φ, 400V, 50Hz
Dimensions H×W×D (mm)	1420×600×780
Weight (kg)	180



### INDOOR UNIT

### DUO 300 / DUO 300 SOLAR with the 300 L tank for domestic hot water

Hot water tank volume (L)	300
Dimensions of gas connections (Φmm)	9.52 / 15.88 (3/8", 5/8")
Dimensions of connections for the heating system (Φmm)	25.4 (1")
Dimensions of hot water connections (Φmm)	circulation (1", 3/4 circulation)
Built-in circulation pump	circulation pump - energy class A
Switchover heating – hot water	Integrated
Electric heater (kW)	3×3
Heat exchanger	Swep
Expansion vessel for heating (L)	12
Power supply (Phase, V, Hz)	3φ, 400V, 50Hz
Dimensions H×W×D (mm)	1820×600×780
Weight (kg)	235
Weight Solar (kg)	255



## ORCA IS ALREADY RESPONSIBLE FOR HEATING OVER 15,000 HOMES IN EUROPE.

Orcas are sociable animals which take great care of their families. They behave so very much like humans that certain tribes believed that human souls were trapped in these beautiful animals. Orcas don't mind the heat or the cold. They live in the extreme cold of the Arctic Sea as well as in the tropical seas near the equator. Despite the cold or the heat, they hunt, socialize and love.

### FREEDOM

You and your family wish to be just as free and independent from weather conditions. And financially as well? Because we share your wishes and values we have given our company the name of this powerful and free sea creature.

### QUALITY

We have top experts from the field of cost-efficient heating working in our development labs, designing the flawless production of heating and cooling systems with advanced technologies and pinpoint precision. To consistently maintain quality, our systems are manufactured in the EU, except for certain components supplied by Mitsubishi Electric and Fujitsu, both high quality manufacturers from Japan. We are aware that purchasing our heating and cooling systems represents a long term investment for you, and that is why we keep the flawless operation of our devices in mind, from the first sketch to the final product.

### ENVIRONMENT

We use green energy sources for our products, and we are very responsible towards the local and global environment. Together we can make a small step towards fighting climate change, which endangers humanity and the oceans of our symbol – the orca.

Your seller

Decades of cooling.  
Decades of comfort.  
[orcaenergy.eu](http://orcaenergy.eu)

NZE-ENG-017-08-30

Photos may differ from the actual product. We take no responsibility for printing errors - Design: Kontrastka